Ritn. storlek  
**A4**Skala  
**1 : 1**Sida  
**1**

Beskrivning

**Epok inåtgående kipp-drehfönster 3+1**

Generell tolerans

**SS-ISO 2768-1, m**

Produktnamn

**LKF1274.2**

Skapad av

**ThomasN**

Skapad datum

**2021-04-22**

Revisionsnr.

Revisionsbeskrivning

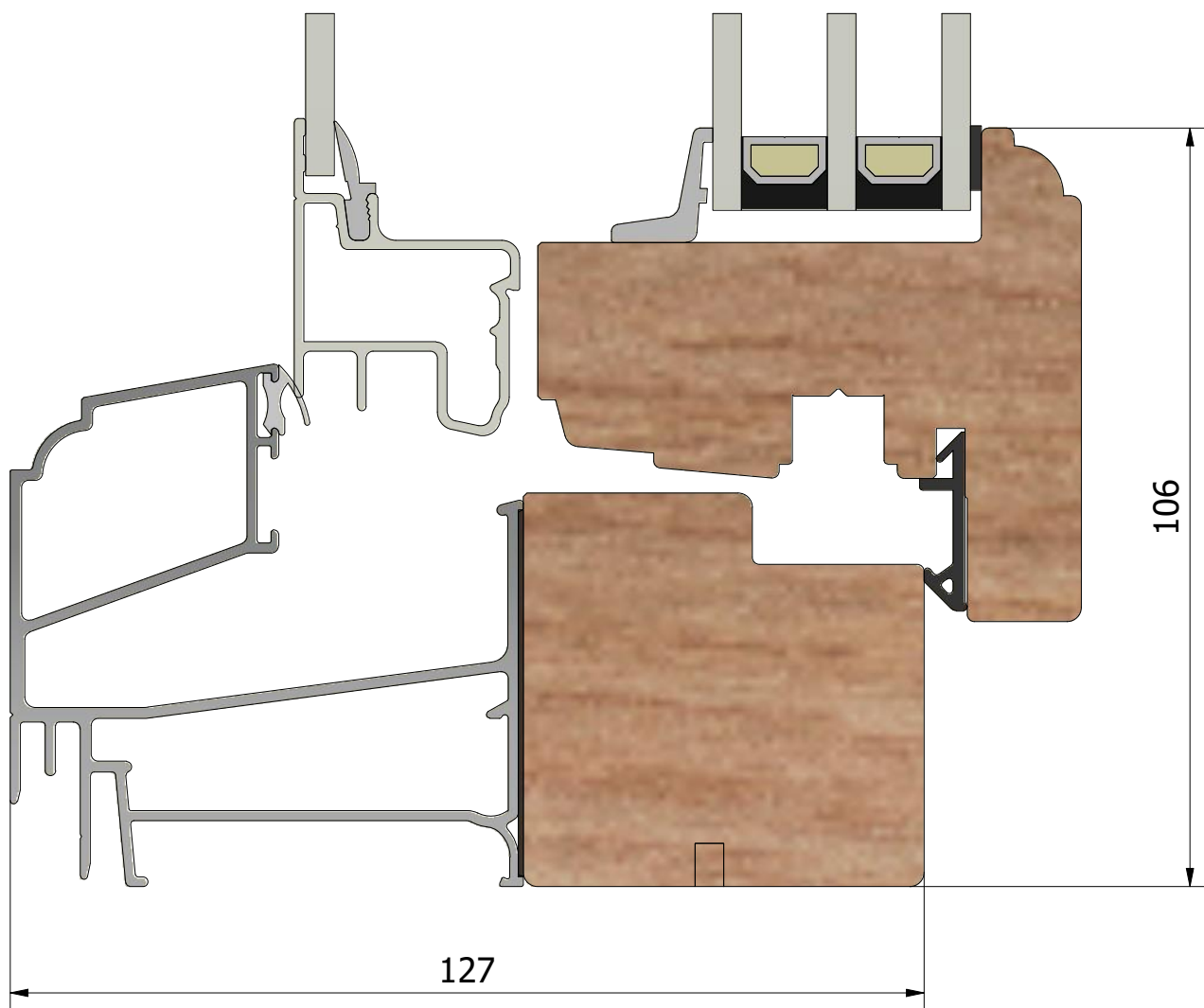
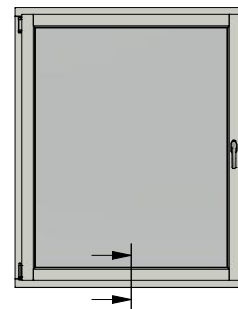
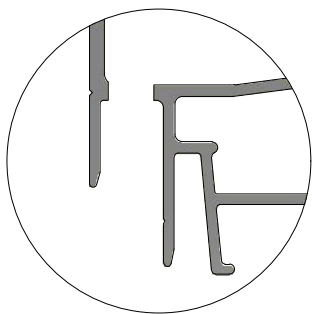
**( 1 : 40 )****Dräneringshål**

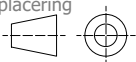

( 1 : 40 )

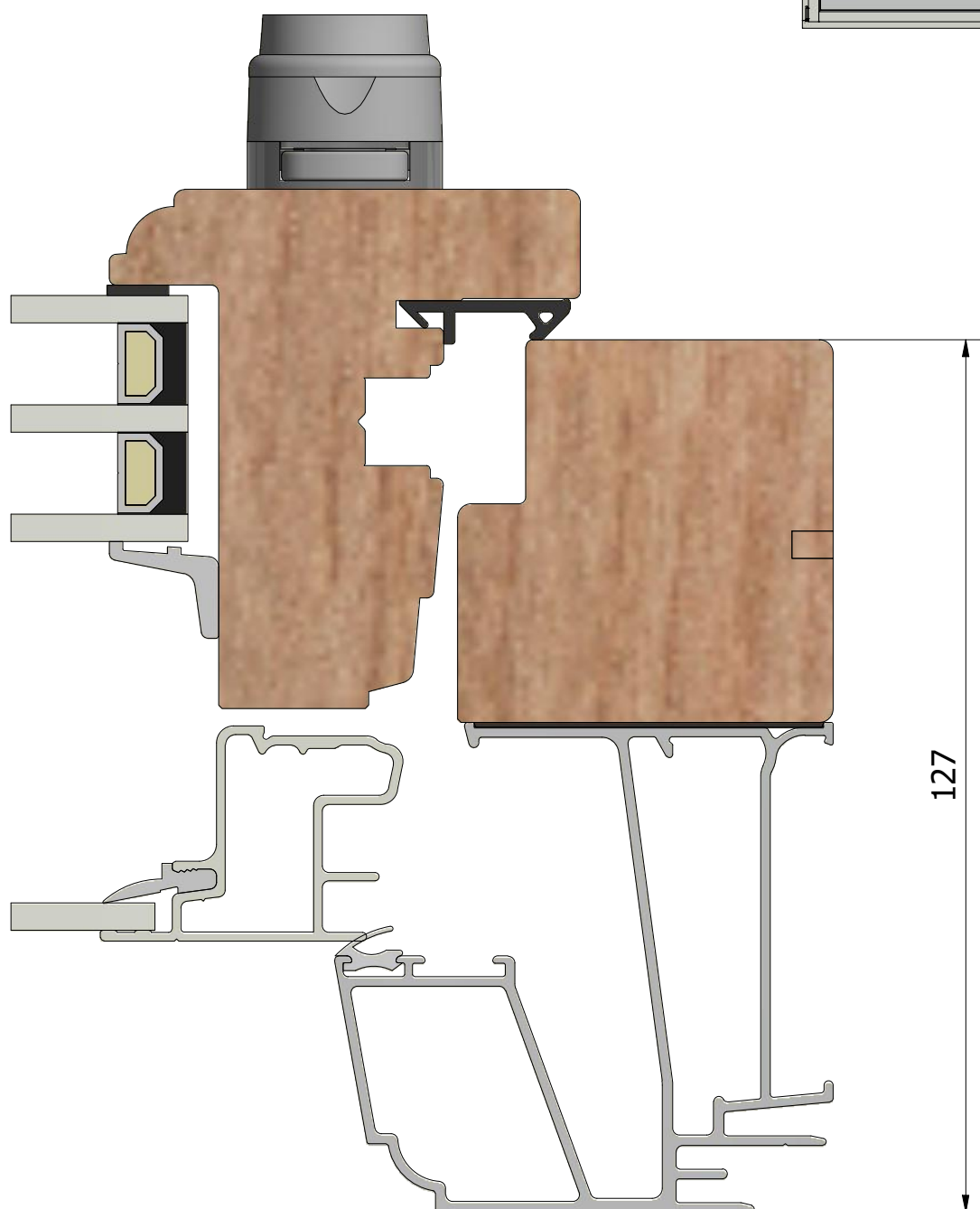
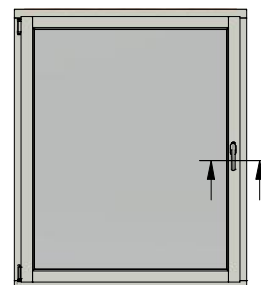

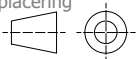

( 1 : 40 )

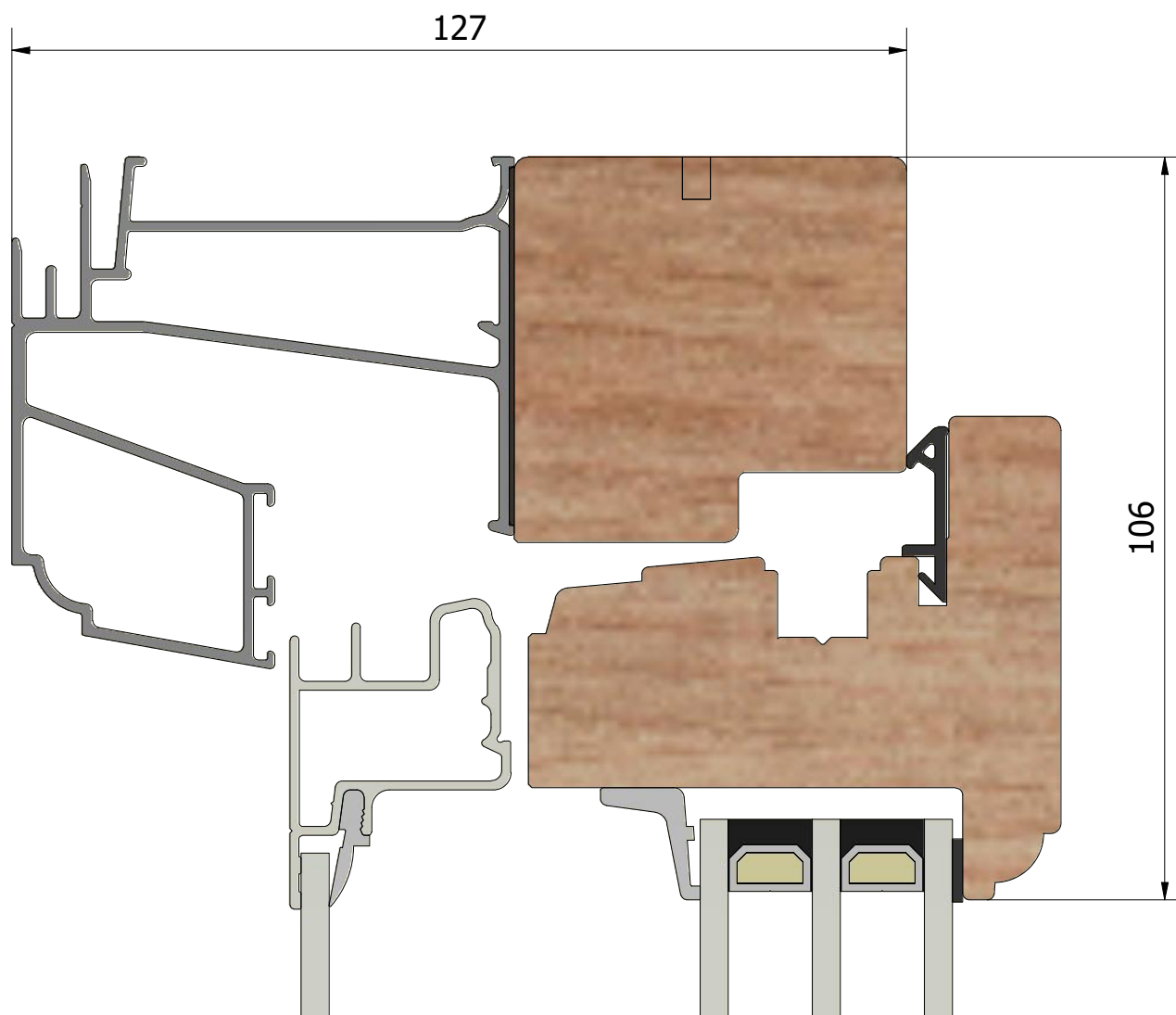
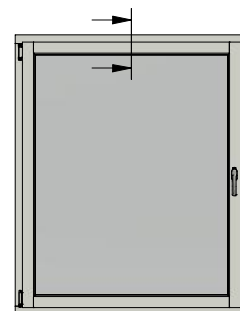

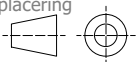

( 1 : 40 )

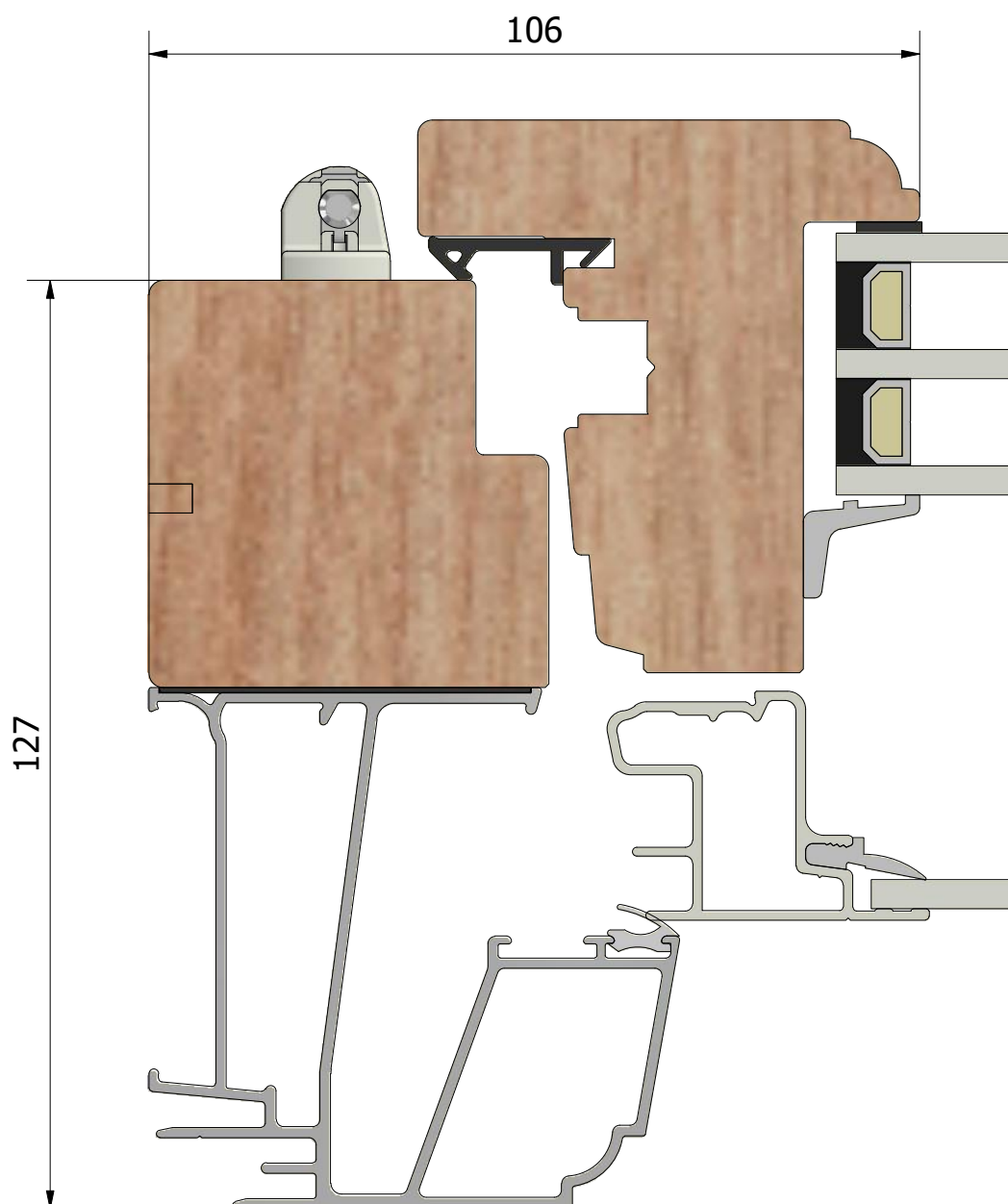
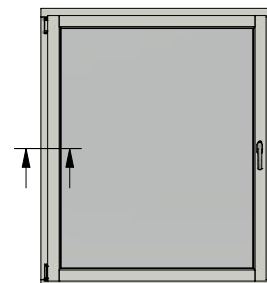

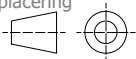
Ritn. storlek  
**A4**Skala  
**1 : 1**Sida  
**5**

Beskrivning

**Epok inåtgående kipp-drehfönster 3+1, mittpost**

Generell tolerans

**SS-ISO 2768-1, m**

Produktnamn

**LKF1274.2**

Skapad av

**ThomasN**

Skapad datum

**2021-04-22**

Revisionsnr.

Revisionsbeskrivning

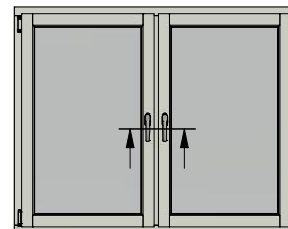
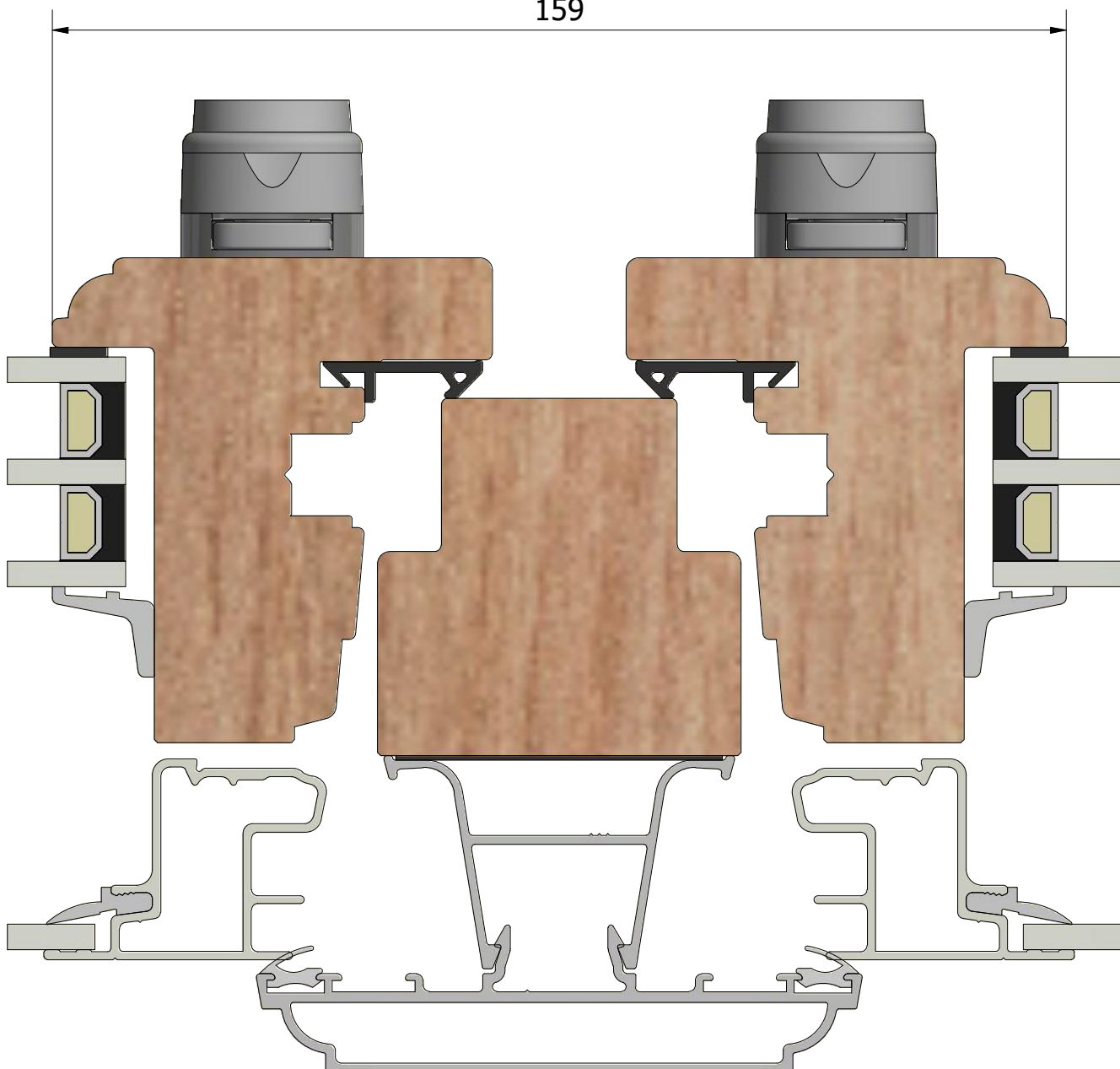
**( 1 : 40 )****159**

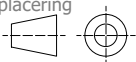

( 1 : 40 )

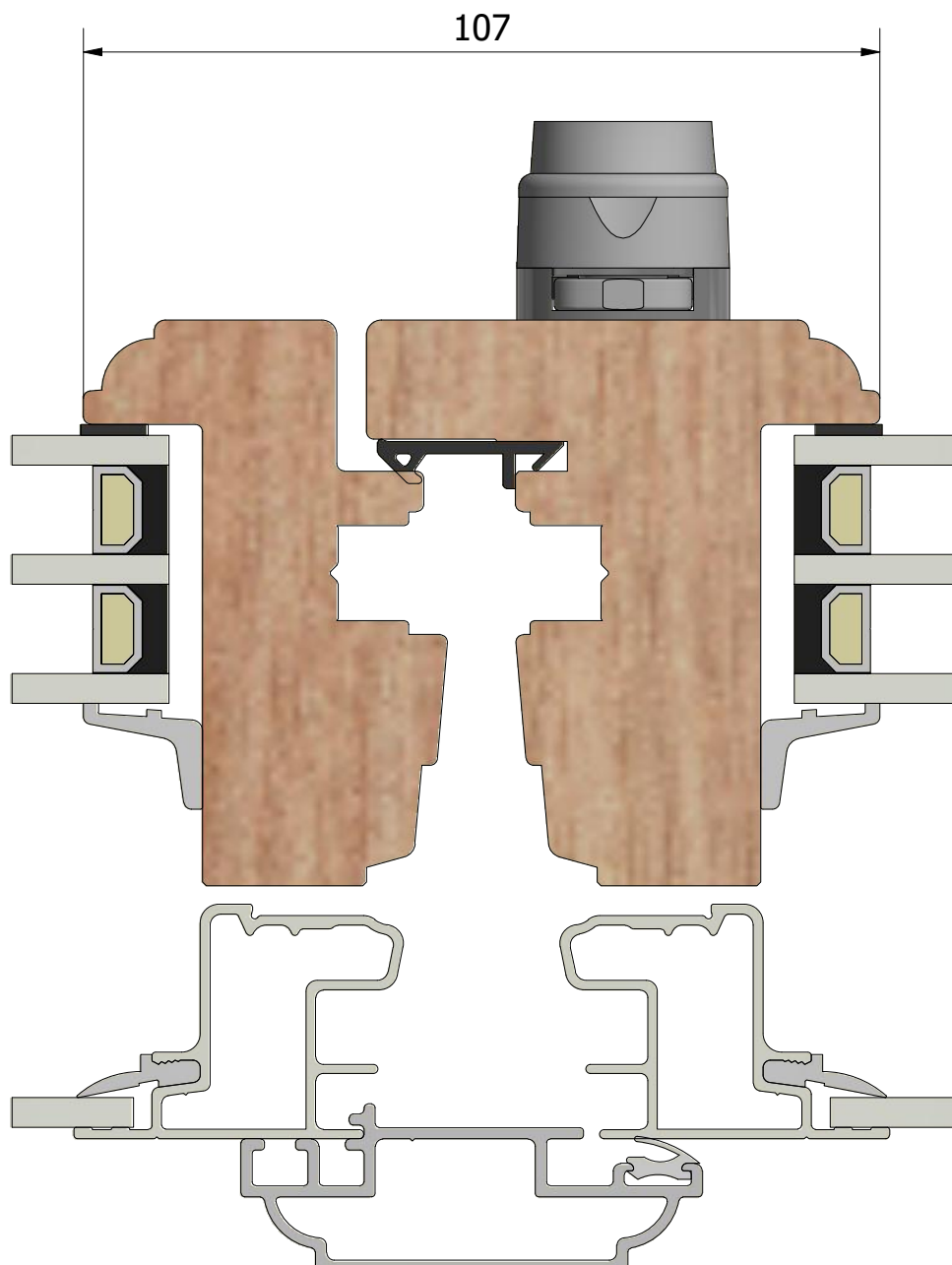
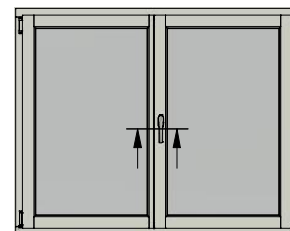

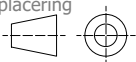

( 1 : 40 )

